

C:\Users\UKLEL75\OneDrive - WSP\0365\Temp\Windfarm\Trecelyn\Design\Residential\Wirelines\62261426-WSP-FG-OL-00005\_R1.lined Originalator: Bryce

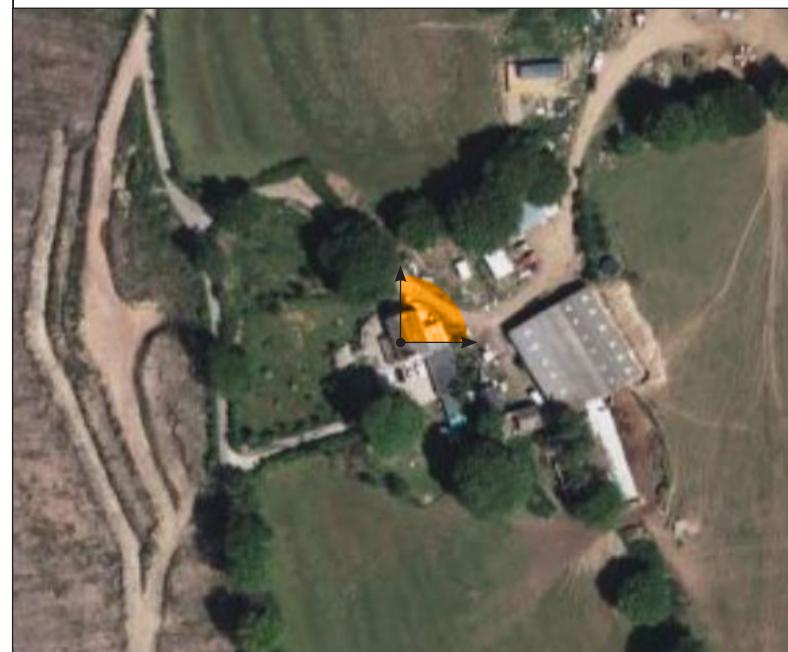

Wireline drawing

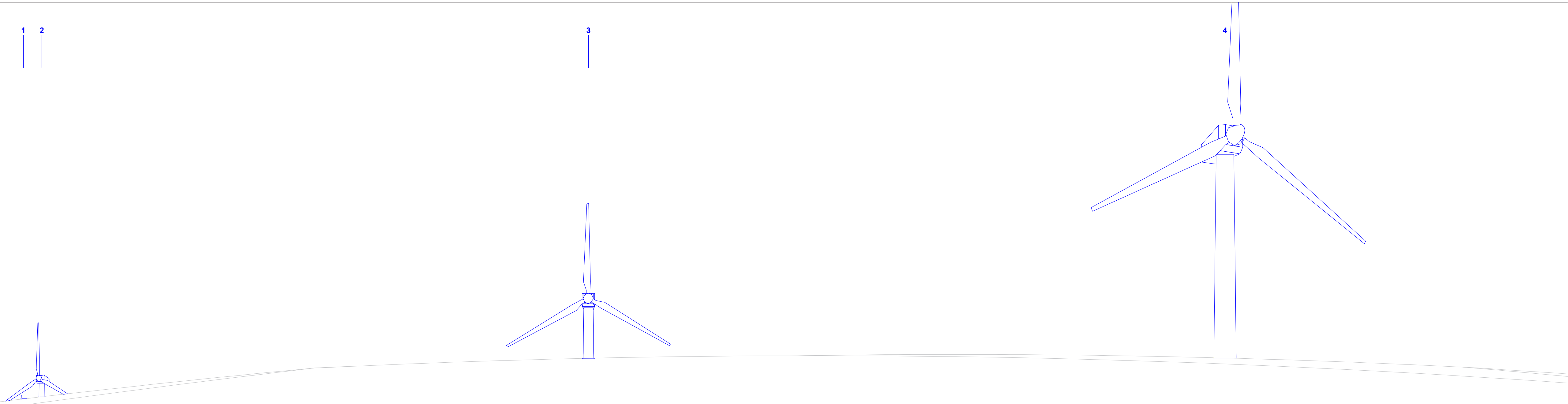

View flat at a comfortable arm's length

Wind Farm Key: Trecelyn Wind Farm Existing Consented Application Scoping

OS reference: E322 466, N195 971  
Eye level: 303.5m AOD  
Direction of view: 45°  
Nearest turbine: 397m  
Horizontal field of view: 90° (cylindrical projection)  
Principal distance: 522mm  
Paper size: 841mm x 297mm (half A1)  
Correct printed image size: 820 x 130mm

Client

Trecelyn Wind Farm  
Landscape and Visual Impact Assessment

Figure 6.18a  
Residential 1: Glan Shon Farm

October 2023



C:\Users\UKLEL75\OneDrive - WSP\03651Temp\Windfarm\Trecelyn\Design\Residential\Wirelines\62281426-WSP-FG-OL-00005\_R1.lined  
Originator: Bryce

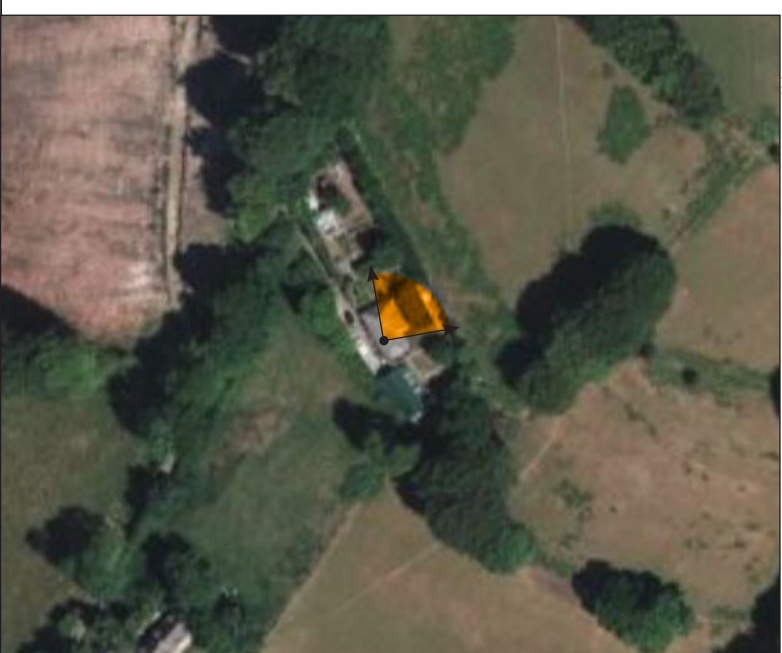

Wireline drawing

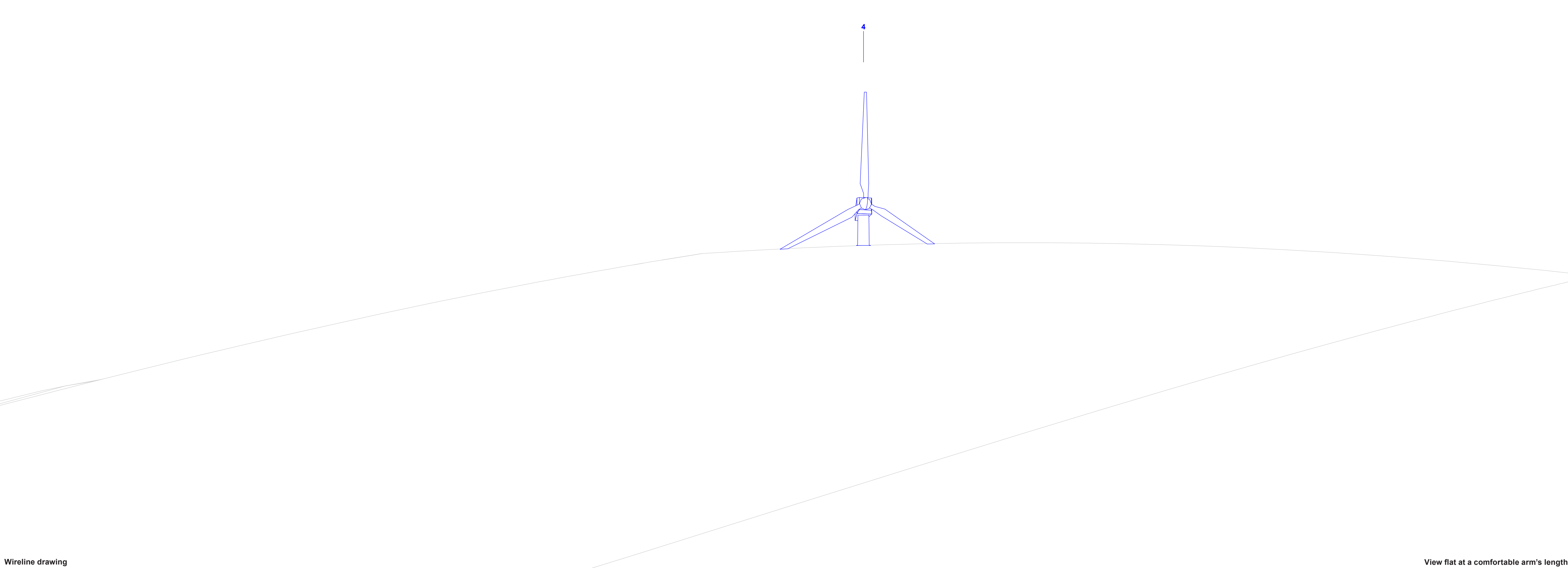

View flat at a comfortable arm's length

Wind Farm Key: Trecelyn Wind Farm Existing Consented Application Scoping

OS reference:	E322 404, N195 546	Horizontal field of view:	90° (cylindrical projection)
Eye level:	255.5m AOD	Principal distance:	522mm
Direction of view:	35°	Paper size:	841mm x 297mm (half A1)
Nearest turbine:	612m	Correct printed image size:	820 x 130mm

Client

Trecelyn Wind Farm  
Landscape and Visual Impact Assessment

Figure 6.18b  
Residential 2: Roxburgh Bungalow

October 2023



C:\Users\UKLEL75\OneDrive - WSP\03651Temp\Windfarm\Trecelyn\Design\Residential\Wirelines\62281426-WSP-FG-OL-00005\_R1.lined  
Originator: Bryce

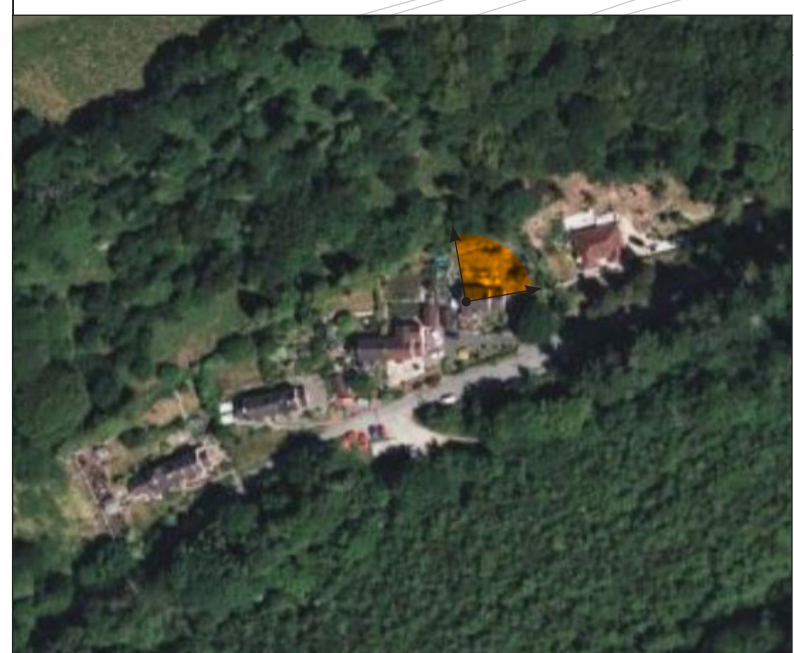

Wireline drawing

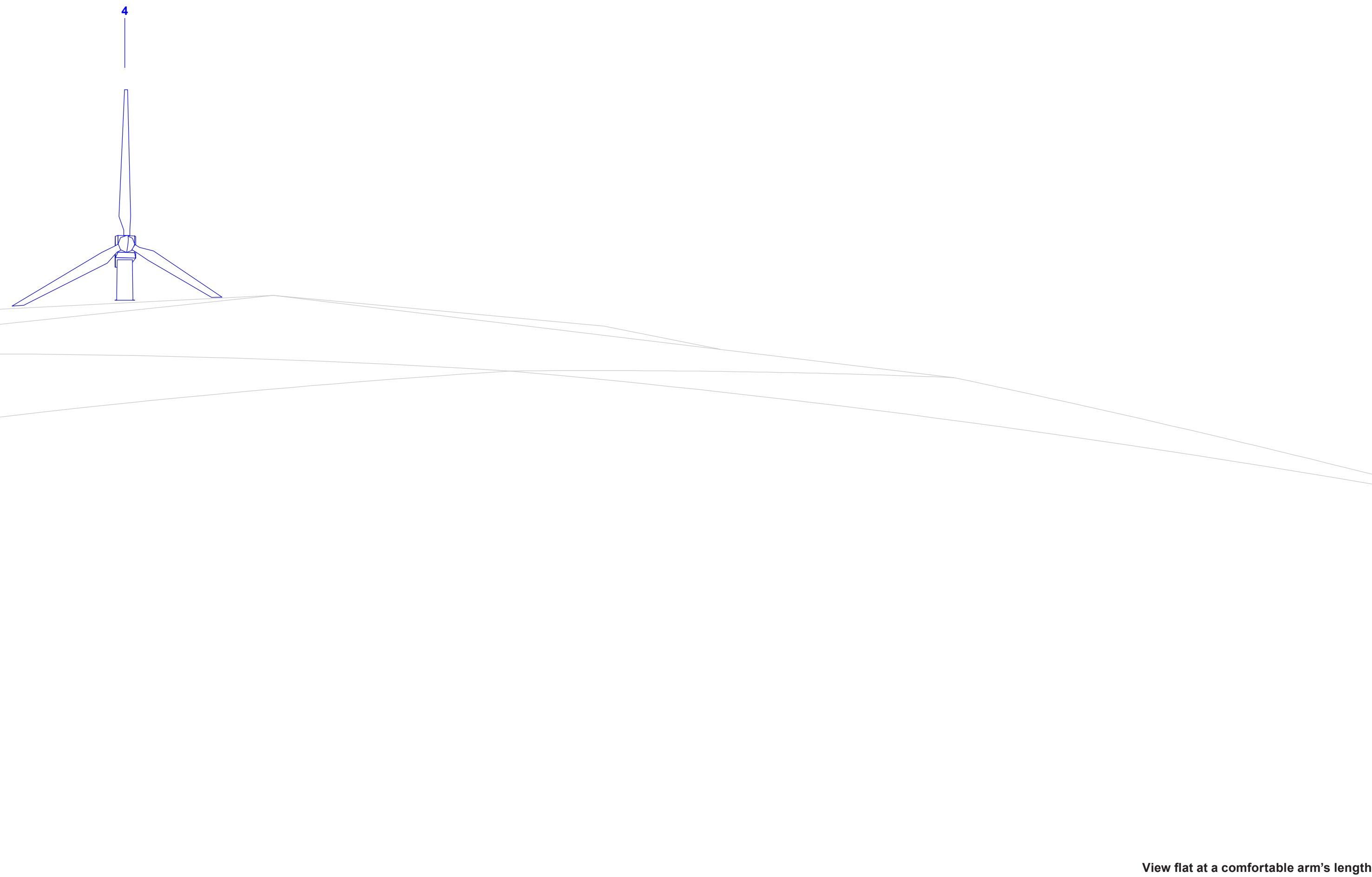

**Wind Farm Key:** Trecelyn Wind Farm Existing Consented Application Scoping

OS reference: E322 347, N195 468  
Eye level: 233.5m AOD  
Direction of view: 35°  
Nearest turbine: 707m  
Horizontal field of view: 90° (cylindrical projection)  
Principal distance: 522mm  
Paper size: 841mm x 297mm (half A1)  
Correct printed image size: 820 x 130mm

Client  
Trecelyn Wind Farm  
Landscape and Visual Impact Assessment

**Figure 6.18c**  
**Residential 3: Graig Wen Houses (east of Abercarn)**

October 2023



View flat at a comfortable arm's length

C:\Users\UKCLE775\OneDrive - WSP\03651Temp\Windfarm\Trecelyn\Design\Residential Wirelines 02261426-WSP-FG-DL-00005\_R1.indd Originator: Bryce

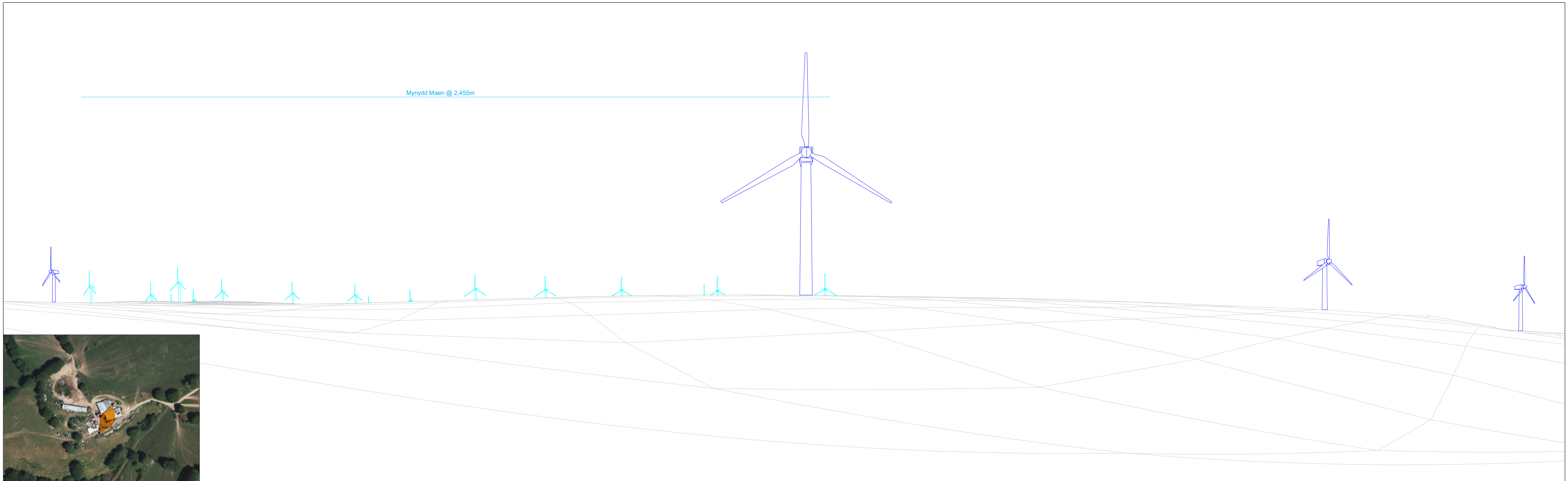

Wireline drawing

View flat at a comfortable arm's length

**Wind Farm Key:** Trecelyn Wind Farm Existing Consented Application Scoping

OS reference:	E322 885, N197 172	Horizontal field of view:	140° (cylindrical projection)
Eye level:	322.5m AOD	Principal distance:	522mm
Direction of view:	115°	Paper size:	841mm x 297mm (half A1)
Nearest turbine:	385m	Correct printed image size:	820 x 130mm

Client  
Trecelyn Wind Farm  
Landscape and Visual Impact Assessment

Client  
Trecelyn Wind Farm  
Landscape and Visual Impact Assessment

**Figure 6.18d**  
**Residential 4: Cil-lonydd**

October 2023





C:\Users\UKLEL75\OneDrive - WSP\0365\Temp\Windfarm\Trecelyn\Design\Residential\Wirelines\02261426-WSP-FG-OL-0005\_R1.lindd  
Originator: Bryce

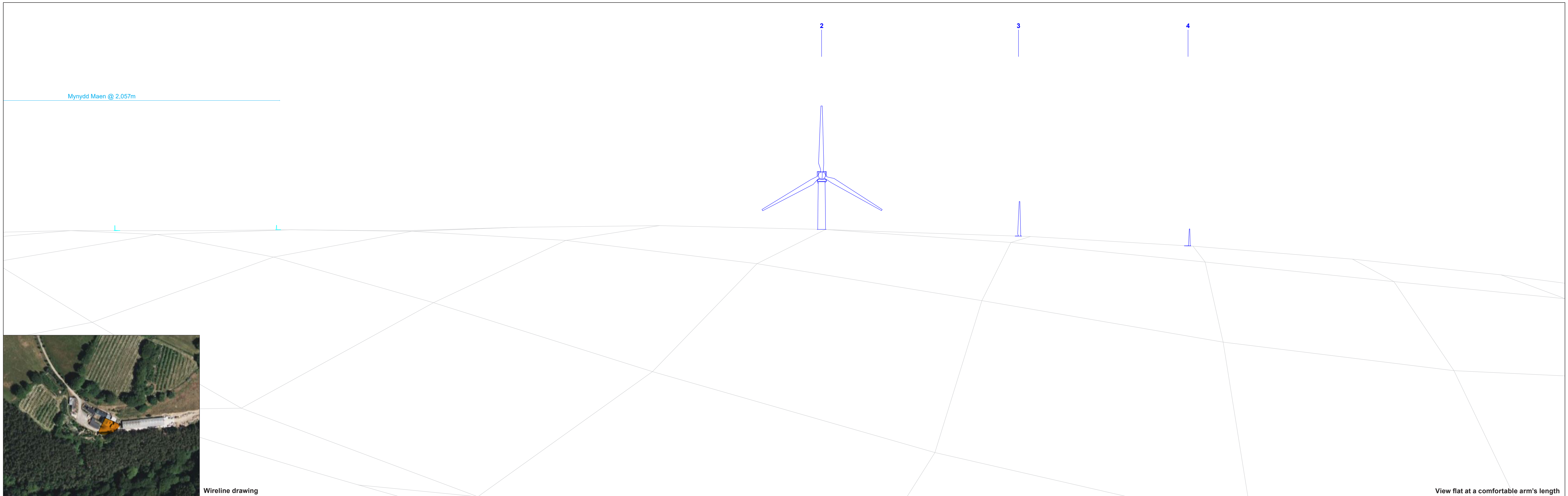

Wireline drawing

View flat at a comfortable arm's length

Wind Farm Key: Trecelyn Wind Farm Existing Consented Application Scoping

OS reference:	E322 969, N197 805	Horizontal field of view:	90° (cylindrical projection)
Eye level:	310.5m AOD	Principal distance:	522mm
Direction of view:	160°	Paper size:	841mm x 297mm (half A1)
Nearest turbine:	848m	Correct printed image size:	820 x 130mm

Client

Trecelyn Wind Farm  
Landscape and Visual Impact Assessment

Figure 6.18e  
Residential 5: Blaengwrney Farm

October 2023



C:\Users\UKLE775\OneDrive - WSP\03651Temp\Windfarm\Trecelyn\Design\Residential Wirelines 62261426-WSP-FG-OL-00005\_R1.indd Originator: Bryce

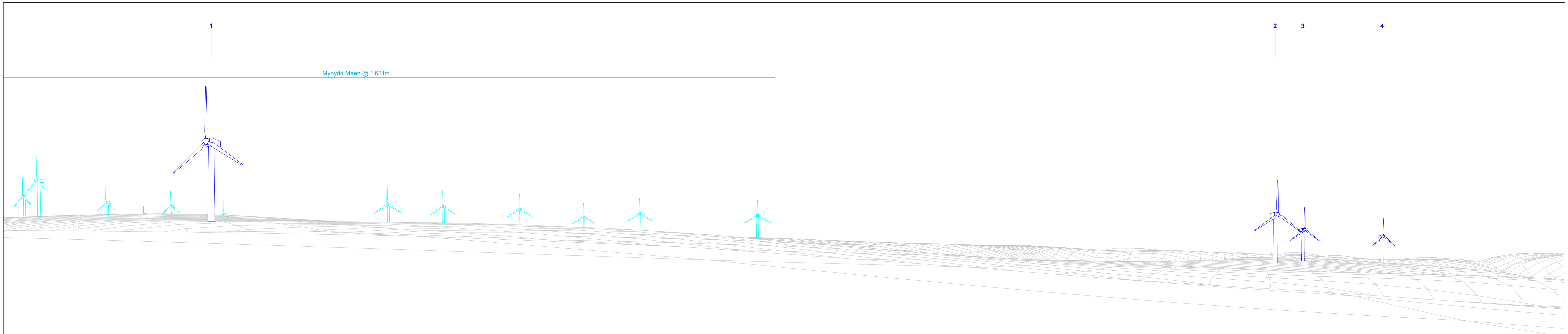

Wireline drawing

**Wind Farm Key:** Trecelyn Wind Farm Existing Consented Application Scoping

OS reference: E323 262, N198 292  
 Eye level: 363.5m AOD  
 Direction of view: 143°  
 Nearest turbine: 791m

Horizontal field of view: 120° (cylindrical projection)  
 Principal distance: 522mm  
 Paper size: 841mm x 297mm (half A1)  
 Correct printed image size: 820 x 130mm

Client

Trecelyn Wind Farm  
 Landscape and Visual Impact Assessment

**Figure 6.18f**  
 Residential 6: Pen-y-caeau Farm

October 2023



View flat at a comfortable arm's length

C:\Users\UKLE775\OneDrive - WSP\0365\Temp\Windfarm\Trecelyn\Design\Residential Wirelines 62261426-WSP-FG-OL-00005\_R1.indd Originator: Bryce

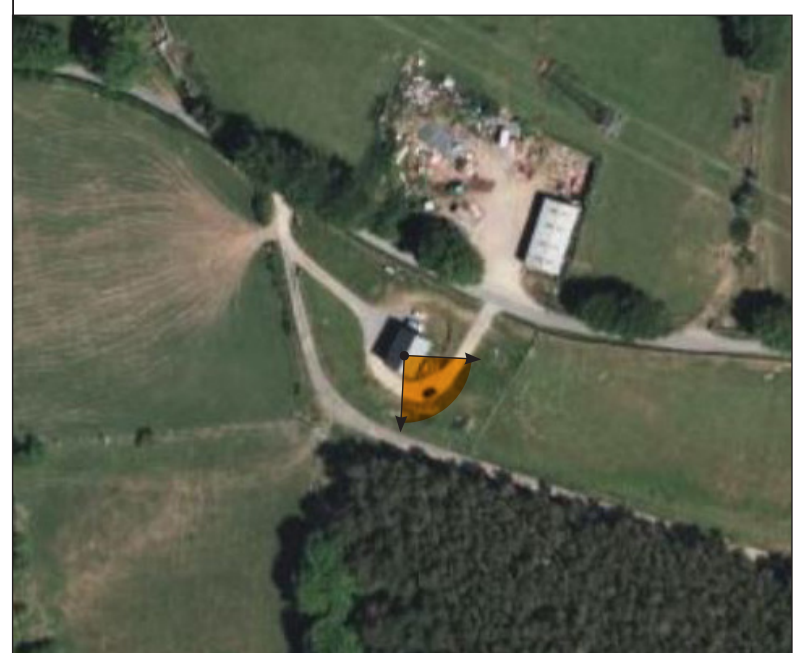
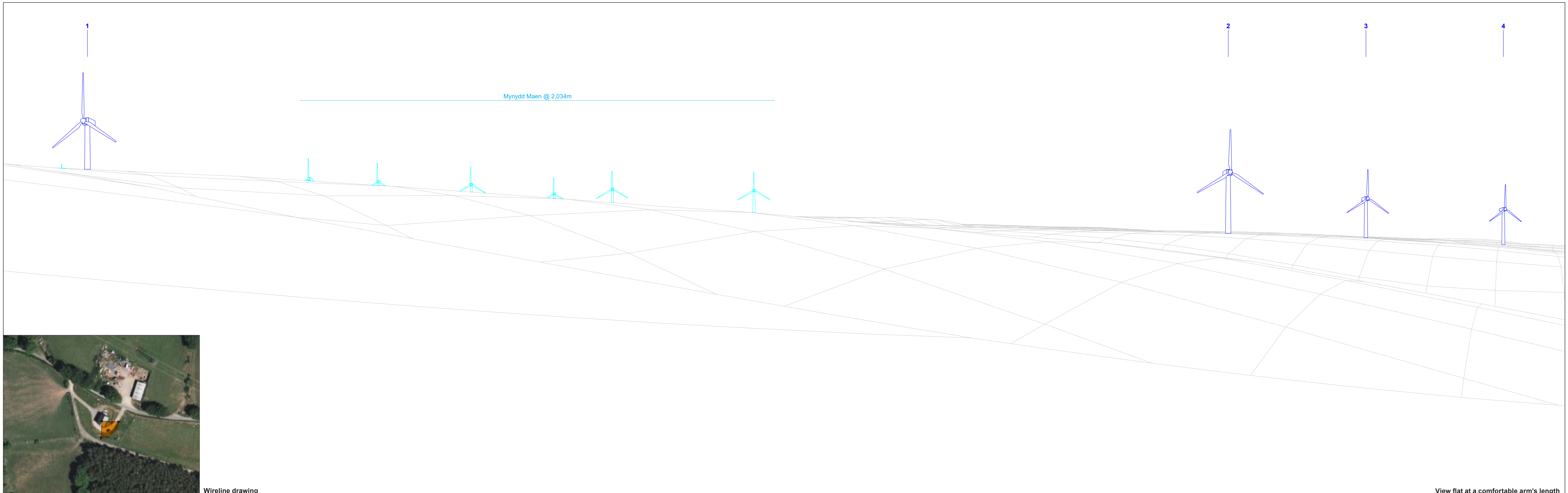

Wireline drawing

View flat at a comfortable arm's length

**Wind Farm Key:** Trecelyn Wind Farm Existing Consented Application Scoping

OS reference:	E322 836, N198 323	Horizontal field of view:	90° (cylindrical projection)
Eye level:	326.5m AOD	Principal distance:	522mm
Direction of view:	137°	Paper size:	841mm x 297mm (half A1)
Nearest turbine:	1,217m	Correct printed image size:	820 x 130mm

Client

Trecelyn Wind Farm  
Landscape and Visual Impact Assessment

**Figure 6.18g**  
**Residential 7: Cefn Gawni (Blaengwrney Farm)**

October 2023





Mynydd Maen @ 2,346m

2

3

4

Wireline drawing

View flat at a comfortable arm's length

C:\Users\UKLE75\OneDrive - WSP\03651Temp\Windfarm\Trecelyn\Design\Residential Wirelines\02261426-WSP-FG-OL-00005\_R1.indd Originator: Bryce

Wind Farm Key:  Trecelyn Wind Farm  Existing  Consented  Application  Scoping

OS reference:	E322 545, N198 178	Horizontal field of view:	90° (cylindrical projection)
Eye level:	291.5m AOD	Principal distance:	522mm
Direction of view:	149°	Paper size:	841mm x 297mm (half A1)
Nearest turbine:	1,364m	Correct printed image size:	820 x 130mm

Client:	Trecelyn Wind Farm Landscape and Visual Impact Assessment
---------	--

**Figure 6.18h**  
Residential 8: Cefn-rhos-y-bedd-uchaf

October 2023 



C:\Users\UKLEL75\OneDrive - WSP\0365\Temp\Windfarm\Trecelyn\Design\Residential\Wirelines\62281426-WSP-FG-OL-00005\_R1.indd Originator: Bryce

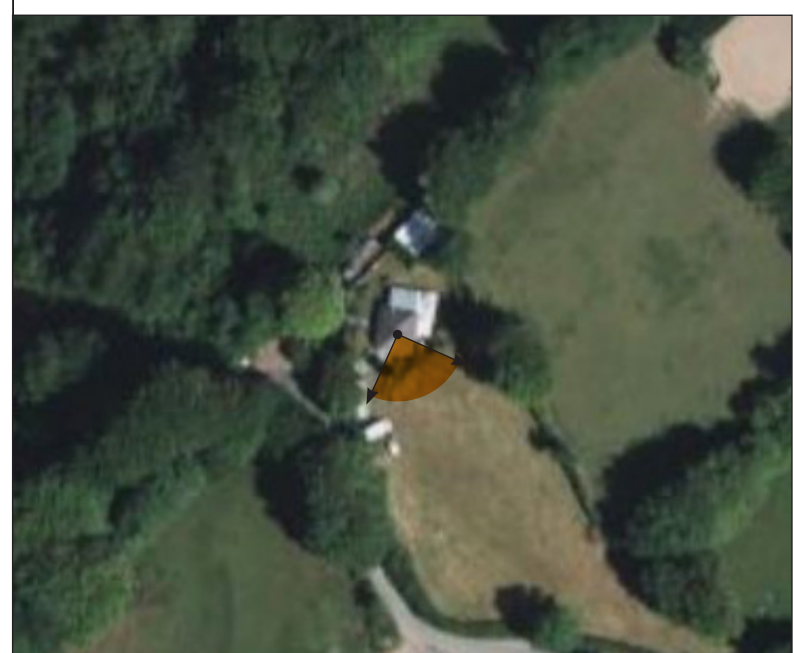

Wireline drawing

Wind Farm Key: Trecelyn Wind Farm Existing Consented Application Scoping

OS reference: E322 950, N199 268  
Eye level: 274.5m AOD  
Direction of view: 159°  
Nearest turbine: 1,556m  
Horizontal field of view: 90° (cylindrical projection)  
Principal distance: 522mm  
Paper size: 841mm x 297mm (half A1)  
Correct printed image size: 820 x 130mm

Client

Trecelyn Wind Farm  
Landscape and Visual Impact Assessment

Figure 6.18i  
Residential 9: Hillcrest Bungalow

View flat at a comfortable arm's length  
October 2023

Mynydd Maen @ 1,705m

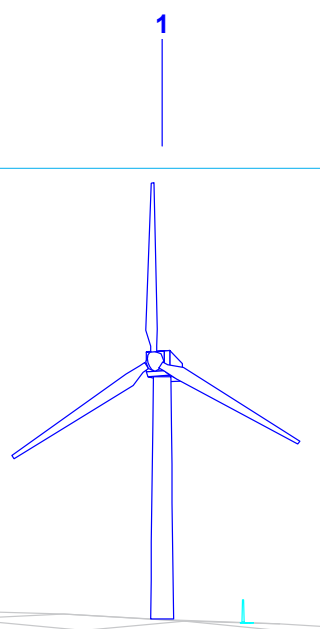

C:\Users\UKLEL75\OneDrive - WSP\03651Temp\Windfarm\Trecelyn\Design\Residential Wirelines 02261426-WSP-FG-OL-00005\_R1.rvt

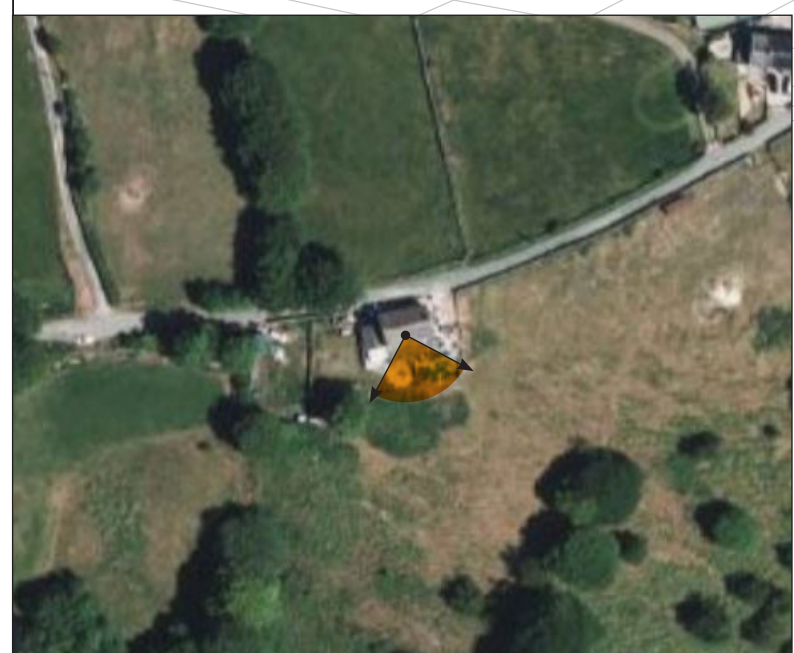

Wireline drawing

View flat at a comfortable arm's length

Wind Farm Key: Trecelyn Wind Farm Existing Consented Application Scoping

OS reference:	E323 222, N199 185	Horizontal field of view:	90° (cylindrical projection)
Eye level:	302.5m AOD	Principal distance:	522mm
Direction of view:	162°	Paper size:	841mm x 297mm (half A1)
Nearest turbine:	1,313m	Correct printed image size:	820 x 130mm

Client

Trecelyn Wind Farm  
Landscape and Visual Impact Assessment

Figure 6.18j  
Residential 10: Rhiw Cottages

October 2023



C:\Users\UKLEL75\OneDrive - WSP\0365\Temp\Windfarm\Trecelyn\Design\Residential\Wirelines\02261426-WSP-FG-OL-00005\_R1.lined

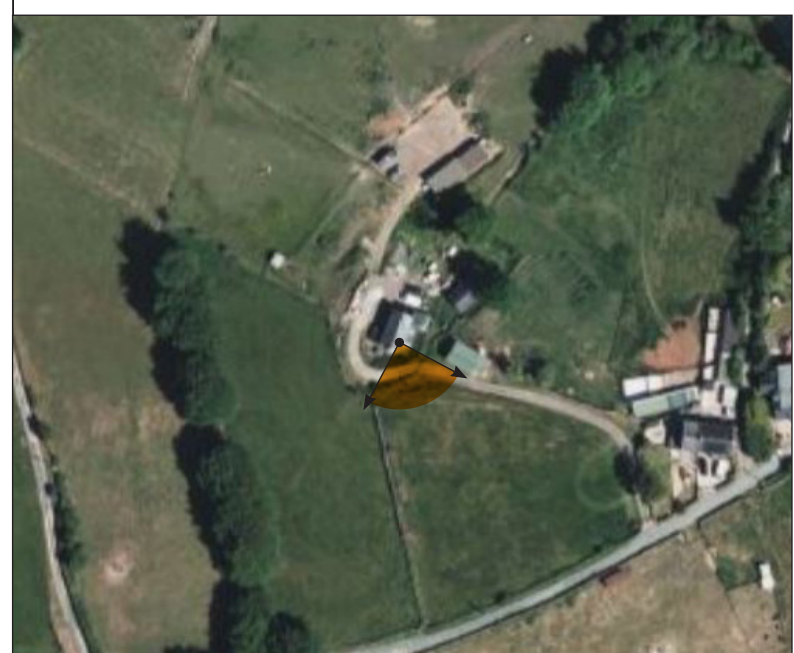

Wireline drawing

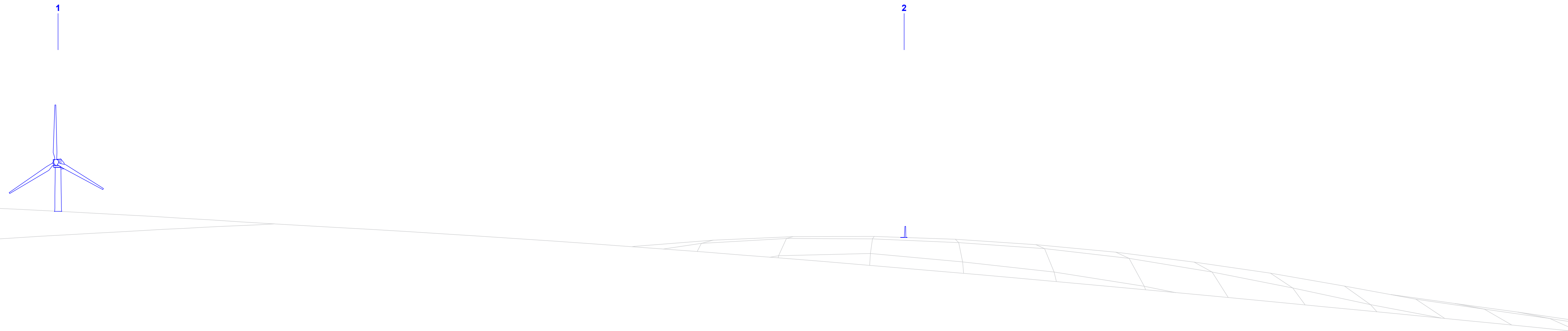

Wind Farm Key: Trecelyn Wind Farm Existing Consented Application Scoping

OS reference: E323 233, N199 284  
Eye level: 304.5m AOD  
Direction of view: 163°  
Nearest turbine: 1,385m  
Horizontal field of view: 90° (cylindrical projection)  
Principal distance: 522mm  
Paper size: 841mm x 297mm (half A1)  
Correct printed image size: 820 x 130mm

Client  
Trecelyn Wind Farm  
Landscape and Visual Impact Assessment

Figure 6.18k  
Residential 11: Ton Cottage, Cefn Y Crib  
& annex

View flat at a comfortable arm's length

October 2023



Mynydd Maen @ 1,619m

1

2



Wireline drawing

View flat at a comfortable arm's length

Wind Farm Key: Trecelyn Wind Farm Existing Consented Application Scoping

OS reference:	E323 344, N199 267	Horizontal field of view:	90° (cylindrical projection)
Eye level:	318.5m AOD	Principal distance:	522mm
Direction of view:	164°	Paper size:	841mm x 297mm (half A1)
Nearest turbine:	1,309m	Correct printed image size:	820 x 130mm

Client

Trecelyn Wind Farm  
Landscape and Visual Impact Assessment

Figure 6.181  
Residential 12: Ty Mawr Cottage

October 2023



C:\Users\UKLEL75\OneDrive - WSP\03651Temp\Windfarm\Trecelyn\Design\Residential\Wireline\02281426-WSP-FG-DL-00005\_R1.indd Originator: Bryce



C:\Users\UKLEL75\OneDrive - WSP\0365\Temp\Windfarm\Trecelyn\Design\Residential Wirelines 62261426-WSP-FG-OL-00005\_R1.indd Originator: Bryce



Wireline drawing

View flat at a comfortable arm's length

**Wind Farm Key:** Trecelyn Wind Farm Existing Consented Application Scoping

OS reference:	E323 348, N199 392	Horizontal field of view:	90° (cylindrical projection)
Eye level:	314.5m AOD	Principal distance:	522mm
Direction of view:	168°	Paper size:	841mm x 297mm (half A1)
Nearest turbine:	1,414m	Correct printed image size:	820 x 130mm

Client  
Trecelyn Wind Farm  
Landscape and Visual Impact Assessment

Client  
Trecelyn Wind Farm  
Landscape and Visual Impact Assessment

**Figure 6.18m**  
**Residential 13: Tram Road Cottage**

October 2023



C:\Users\UKLE175\OneDrive - WSP\03651Temp\Windfarm\Trecelyn\Design\Residential\Wirelines\62281426-WSP-FG-OL-00005\_R1.lined

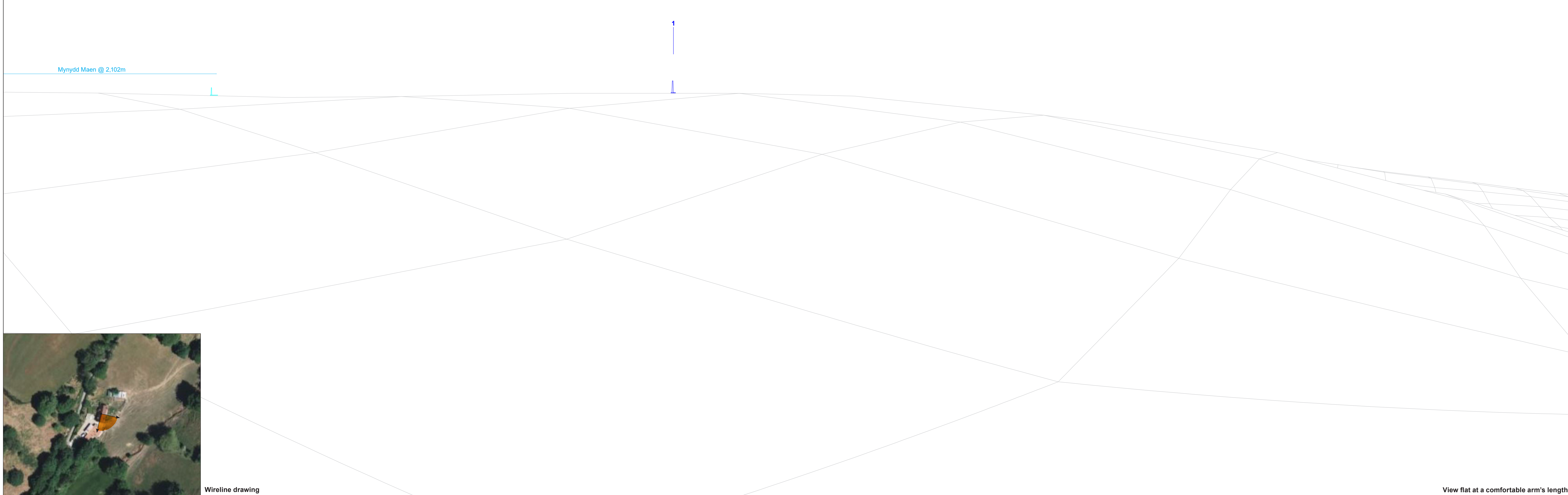

Wireline drawing

View flat at a comfortable arm's length

Wind Farm Key: Trecelyn Wind Farm Existing Consented Application Scoping

OS reference: E322 928, N199 521  
Eye level: 249.5m AOD  
Direction of view: 147°  
Nearest turbine: 1,459m  
Horizontal field of view: 90° (cylindrical projection)  
Principal distance: 522mm  
Paper size: 841mm x 297mm (half A1)  
Correct printed image size: 820 x 130mm

Client  
Trecelyn Wind Farm  
Landscape and Visual Impact Assessment

Figure 6.18n  
Residential 14: Cwm Farm, Pontbren  
Road

October 2023



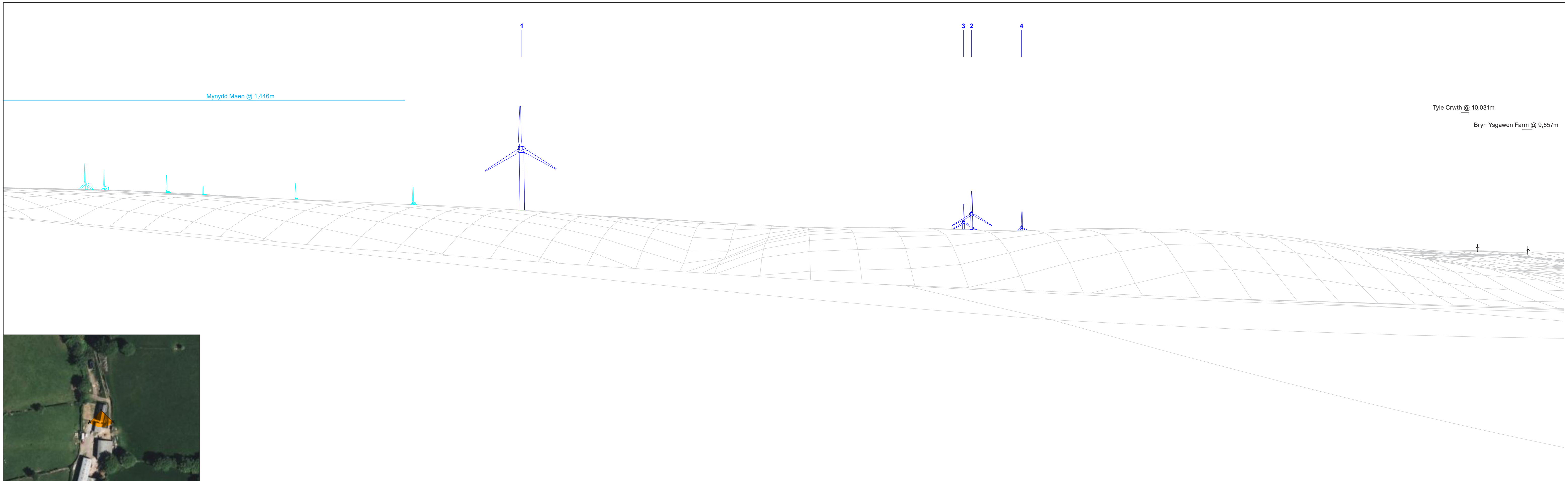

Wireline drawing

View flat at a comfortable arm's length

**Wind Farm Key:** Trecelyn Wind Farm Existing Consented Application Scoping

OS reference:	E323 659, N199 485	Horizontal field of view:	90° (cylindrical projection)
Eye level:	344.5m AOD	Principal distance:	522mm
Direction of view:	179°	Paper size:	841mm x 297mm (half A1)
Nearest turbine:	1,380m	Correct printed image size:	820 x 130mm

Client

Trecelyn Wind Farm  
Landscape and Visual Impact Assessment

**Figure 6.18o**  
**Residential 15: Ty Lan-Twyn**

October 2023



C:\Users\UKLEL75\OneDrive - WSP\03651Temp\Windfarm\Trecelyn\Design\Residential Wirelines\02261426-WSP-FG-OL-00005\_R1.indd Originator: Bryce

C:\Users\UKCLE75\OneDrive - WSP\03651Temp\Windfarm\Trecelyn\Design\Residential Wirelines\02261426-WSP-FG-OL-00005\_R1.indd Originator: Bryce

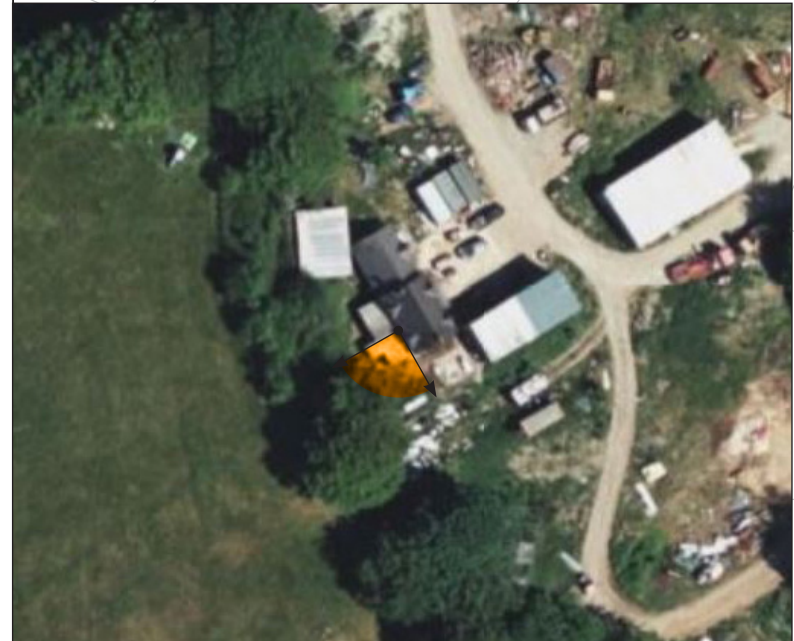
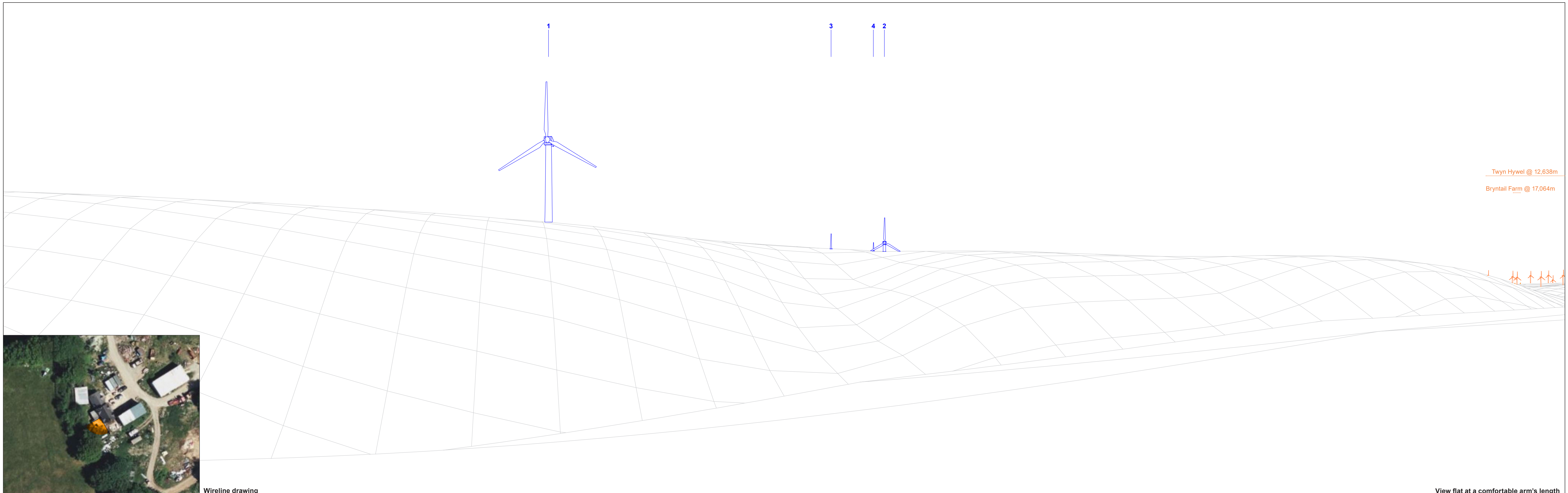

Wireline drawing

View flat at a comfortable arm's length

**Wind Farm Key:** Trecelyn Wind Farm Existing Consented Application Scoping

OS reference:	E324 076, N199 172	Horizontal field of view:	90° (cylindrical projection)
Eye level:	336.5m AOD	Principal distance:	522mm
Direction of view:	135°	Paper size:	841mm x 297mm (half A1)
Nearest turbine:	925m	Correct printed image size:	820 x 130mm

Client  
Trecelyn Wind Farm  
Landscape and Visual Impact Assessment

Client  
Trecelyn Wind Farm  
Landscape and Visual Impact Assessment

**Figure 6.18p**  
**Residential 16: Tir-Shon-Shenkin**

October 2023





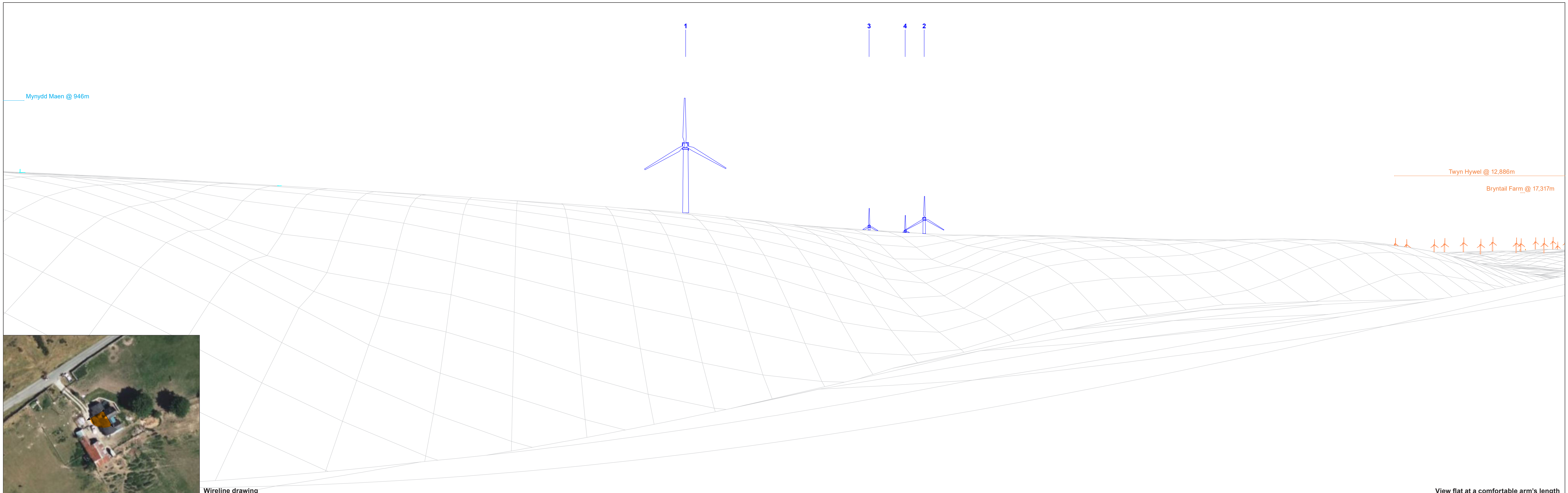

**Wind Farm Key:** Trecelyn Wind Farm Existing Consented Application Scoping

OS reference: E324 241, N199 385  
 Eye level: 353.5m AOD  
 Direction of view: 195°  
 Nearest turbine: 1,242m

Horizontal field of view: 90° (cylindrical projection)  
 Principal distance: 522mm  
 Paper size: 841mm x 297mm (half A1)  
 Correct printed image size: 820 x 130mm

Client  
 Trecelyn Wind Farm  
 Landscape and Visual Impact Assessment

**Figure 6.18q**  
 Residential 17: Cefn-Crib Farm

View flat at a comfortable arm's length  
 October 2023



C:\Users\UKLEL75\OneDrive - WSP\03651Temp\Windfarm\Trecelyn\Design\Residential\Wireline\02281426-WSP-FG-DL-00005\_R1.indd Originator: Bryce

Mynydd Maen @ 1,363m

Tyle Crwth @ 9,867m

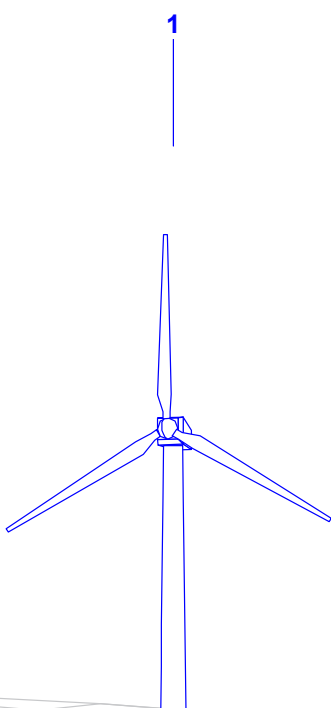

C:\Users\UKLE775\OneDrive - WSP\03651Temp\Windfarm\Trecelyn\Design\Residential Wirelines 02281426-WSP-FG-OL-00005\_R1.rvt



Wireline drawing

View flat at a comfortable arm's length

Wind Farm Key: Trecelyn Wind Farm Existing Consented Application Scoping

OS reference:	E324 428, N199 642	Horizontal field of view:	90° (cylindrical projection)
Eye level:	336.5m AOD	Principal distance:	522mm
Direction of view:	175°	Paper size:	841mm x 297mm (half A1)
Nearest turbine:	1,201m	Correct printed image size:	820 x 130mm

Client	Trecelyn Wind Farm
	Landscape and Visual Impact Assessment

Figure 6.18r  
Residential 18: Bwthyn Yr Ysgol

October 2023



C:\Users\UKLE75\OneDrive - WSP\0365\Temp\Windfarm\Trecelyn\Design\Residential Wirelines 62261426-WSP-FG-DL-00005\_R1.indd Originator: Bycc

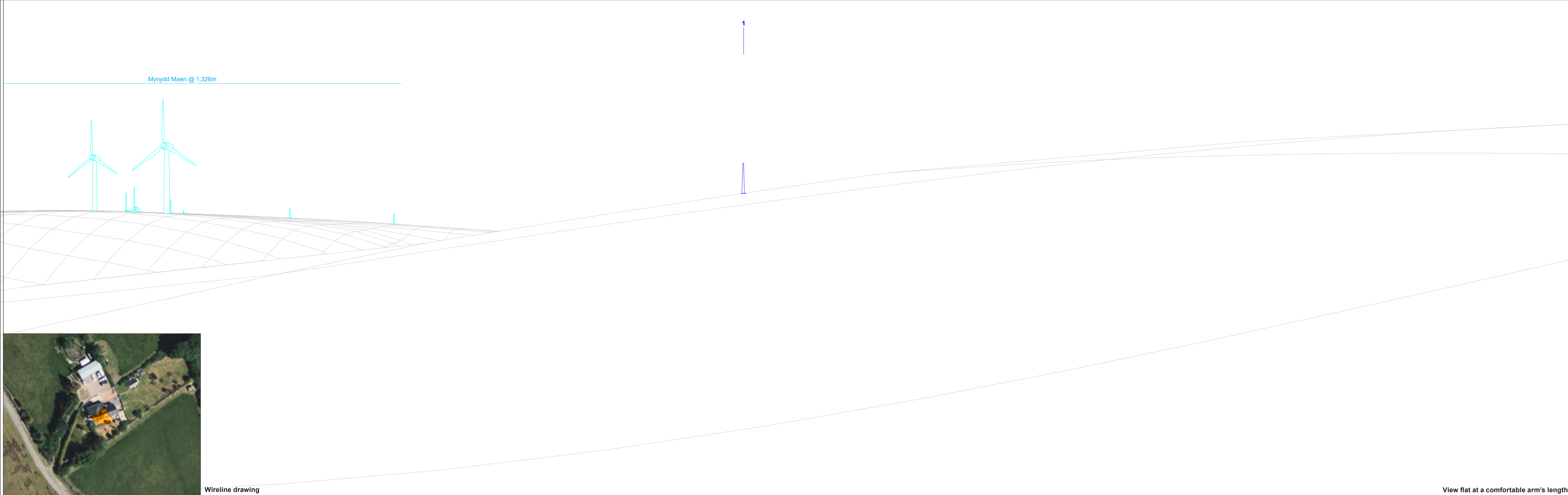

Wireline drawing

View flat at a comfortable arm's length

**Wind Farm Key:** Trecelyn Wind Farm Existing Consented Application Scoping

OS reference:	E324 281, N199 856	Horizontal field of view:	90° (cylindrical projection)
Eye level:	361.5m AOD	Principal distance:	522mm
Direction of view:	190°	Paper size:	841mm x 297mm (half A1)
Nearest turbine:	1,088m	Correct printed image size:	820 x 130mm

Client  
Trecelyn Wind Farm  
Landscape and Visual Impact Assessment

**Figure 6.18s**  
**Residential 19: Cefn Y Crib Farm**

October 2023





C:\Users\UKCLE75\OneDrive - WSP\03651Temp\Windfarm\Trecelyn\Design\Residential Wirelines\62261426-WSP-FG-OL-00005\_R1.lined  
Originator: Bryce

Mynydd Maen @ 1,543m

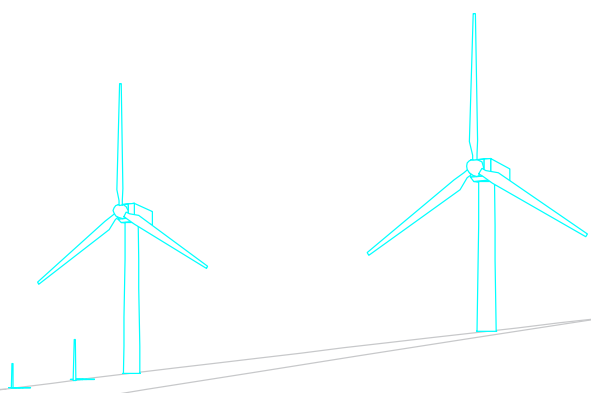

Wireline drawing

View flat at a comfortable arm's length

**Wind Farm Key:** Trecelyn Wind Farm Existing Consented Application Scoping

OS reference:	E324 403, N200 133	Horizontal field of view:	90° (cylindrical projection)
Eye level:	320.5m AOD	Principal distance:	522mm
Direction of view:	198°	Paper size:	841mm x 297mm (half A1)
Nearest turbine:	787m	Correct printed image size:	820 x 130mm

Client

Trecelyn Wind Farm  
Landscape and Visual Impact Assessment

**Figure 6.18t**  
Residential 20: Ty Mary-Harry

October 2023





C:\Users\UKCLE75\OneDrive - WSP\03651Temp\Windfarm\Trecelyn\Design\Residential\Wirelines\62281426-WSP-FG-OL-00005\_R1.lind

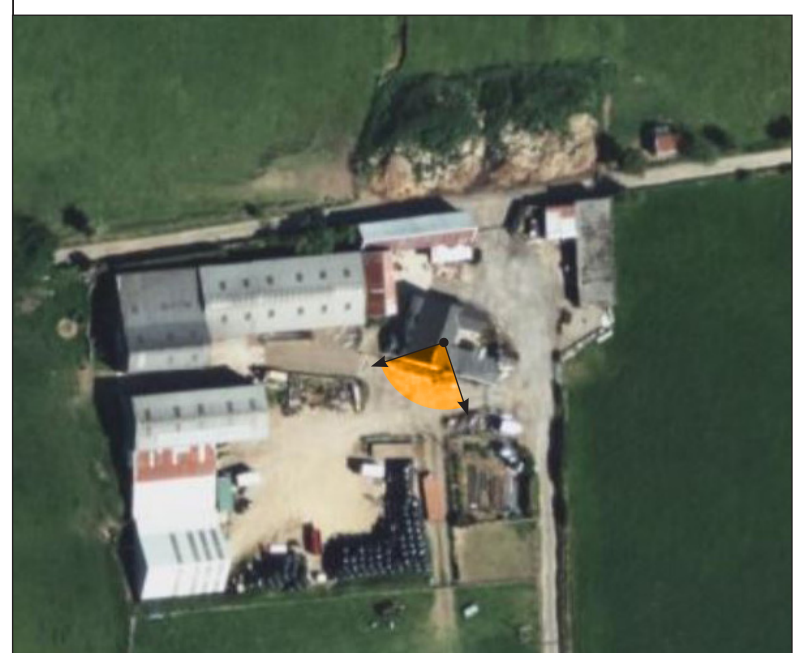
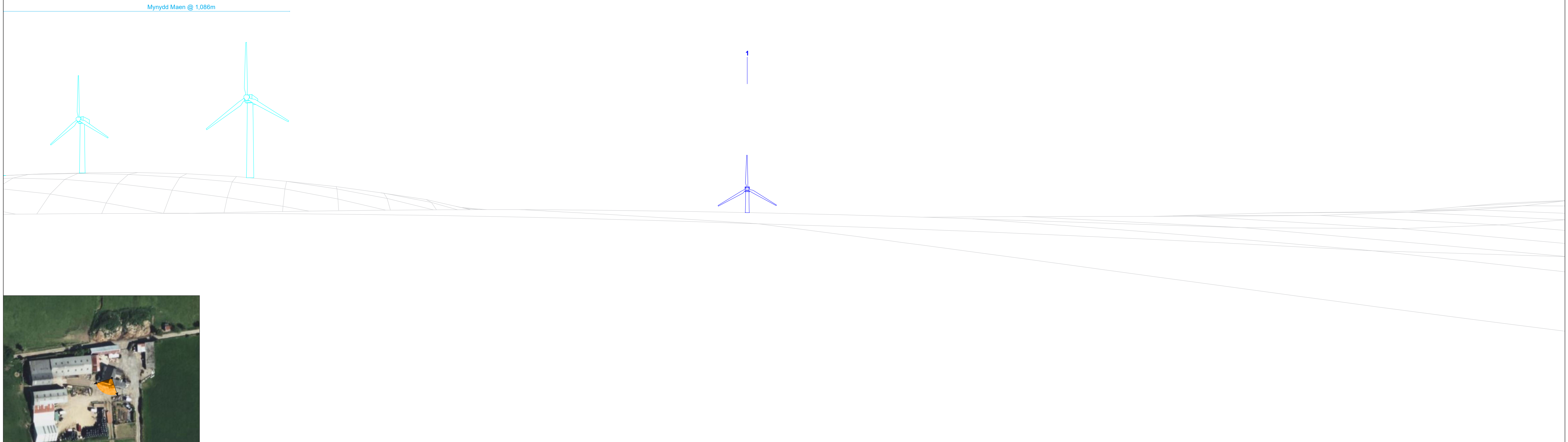

Wireline drawing

View flat at a comfortable arm's length

**Wind Farm Key:** Trecelyn Wind Farm Existing Consented Application Scoping

OS reference:	E324 768, N199 738	Horizontal field of view:	90° (cylindrical projection)
Eye level:	330.5m AOD	Principal distance:	522mm
Direction of view:	206°	Paper size:	841mm x 297mm (half A1)
Nearest turbine:	1,068m	Correct printed image size:	820 x 130mm

Client  
Trecelyn Wind Farm  
Landscape and Visual Impact Assessment

**Figure 6.18u**  
**Residential 21: Tirpentwys Farm**

October 2023



C:\Users\UKLE75\OneDrive - WSP\0365\Temp\Windfarm\Trecelyn\Design\Residential Wirelines 62261426-WSP-FG-OL-00005\_R1.indd Originator: Bryce

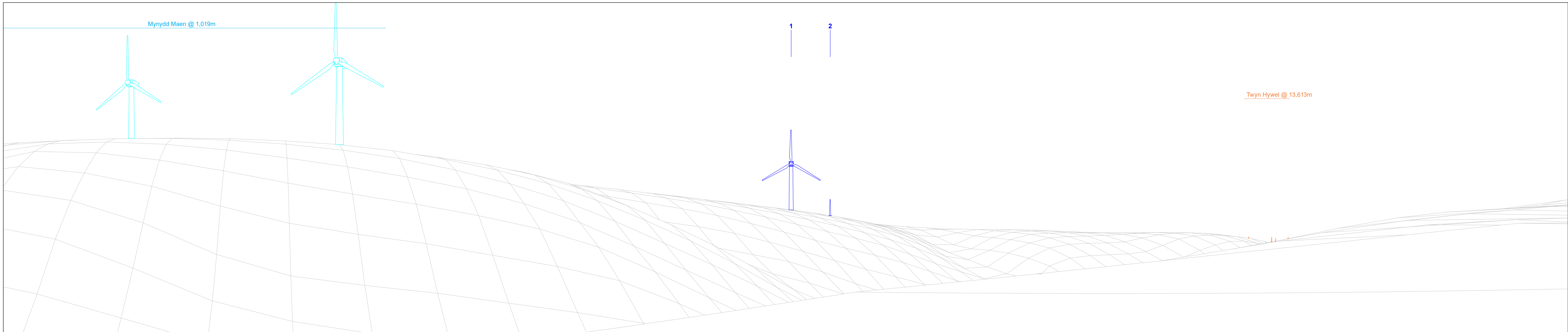

Wireline drawing

**Wind Farm Key:** Trecelyn Wind Farm Existing Consented Application Scoping

OS reference: E324 914, N199 671  
 Eye level: 332.5m AOD  
 Direction of view: 209°  
 Nearest turbine: 1,019m  
 Horizontal field of view: 90° (cylindrical projection)  
 Principal distance: 522mm  
 Paper size: 841mm x 297mm (half A1)  
 Correct printed image size: 820 x 130mm

Client

Trecelyn Wind Farm  
 Landscape and Visual Impact Assessment

**Figure 6.18v**  
 Residential 22: Pwll-Y-Domen Farm

October 2023



View flat at a comfortable arm's length

C:\Users\UKLEL75\OneDrive - WSP\0365\Temp\Windfarm\Trecelyn\Design\Residential\Wirelines\02261426-WSP-FG-OL-00005\_R1.rvt

Originator: Bryce

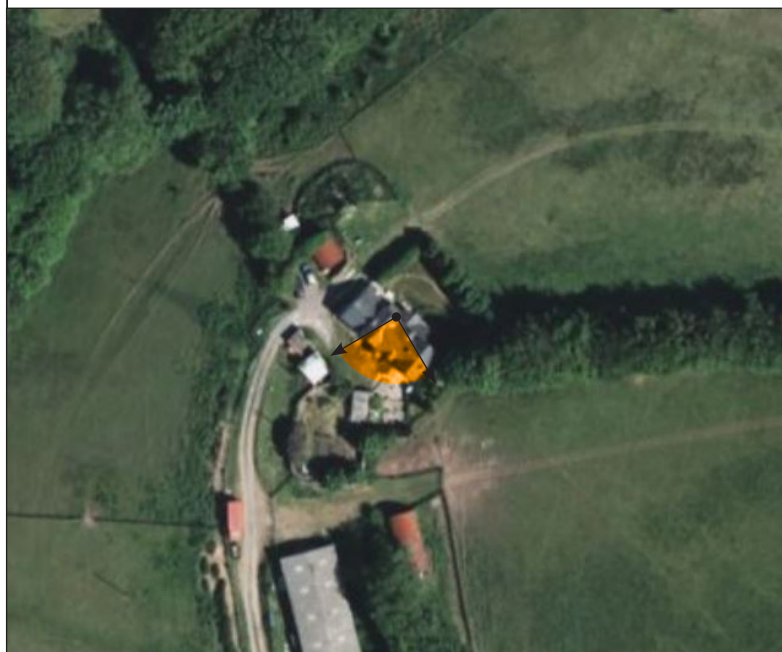
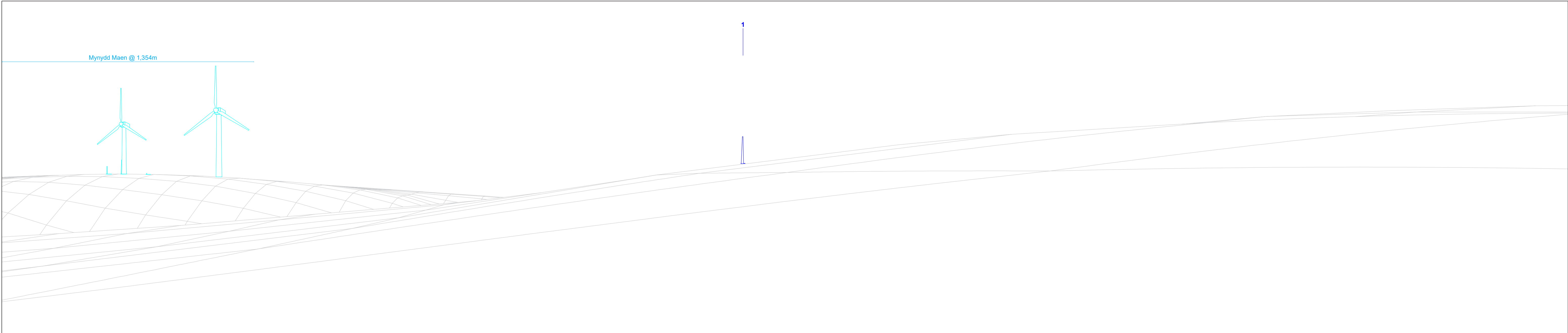

Wireline drawing

View flat at a comfortable arm's length

**Wind Farm Key:** Trecelyn Wind Farm Existing Consented Application Scoping

OS reference:	E324 424, N199 942	Horizontal field of view:	90° (cylindrical projection)
Eye level:	338.5m AOD	Principal distance:	522mm
Direction of view:	194°	Paper size:	841mm x 297mm (half A1)
Nearest turbine:	947m	Correct printed image size:	820 x 130mm

Client  
Trecelyn Wind Farm  
Landscape and Visual Impact Assessment

Client  
Trecelyn Wind Farm  
Landscape and Visual Impact Assessment

**Figure 6.18w**  
**Residential 23: Ty'-r-hen-forwyn**

October 2023





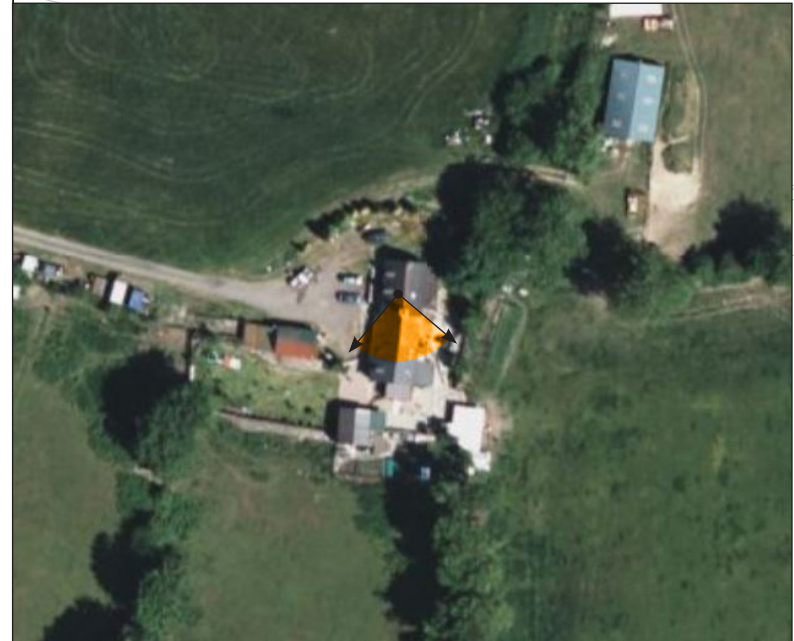
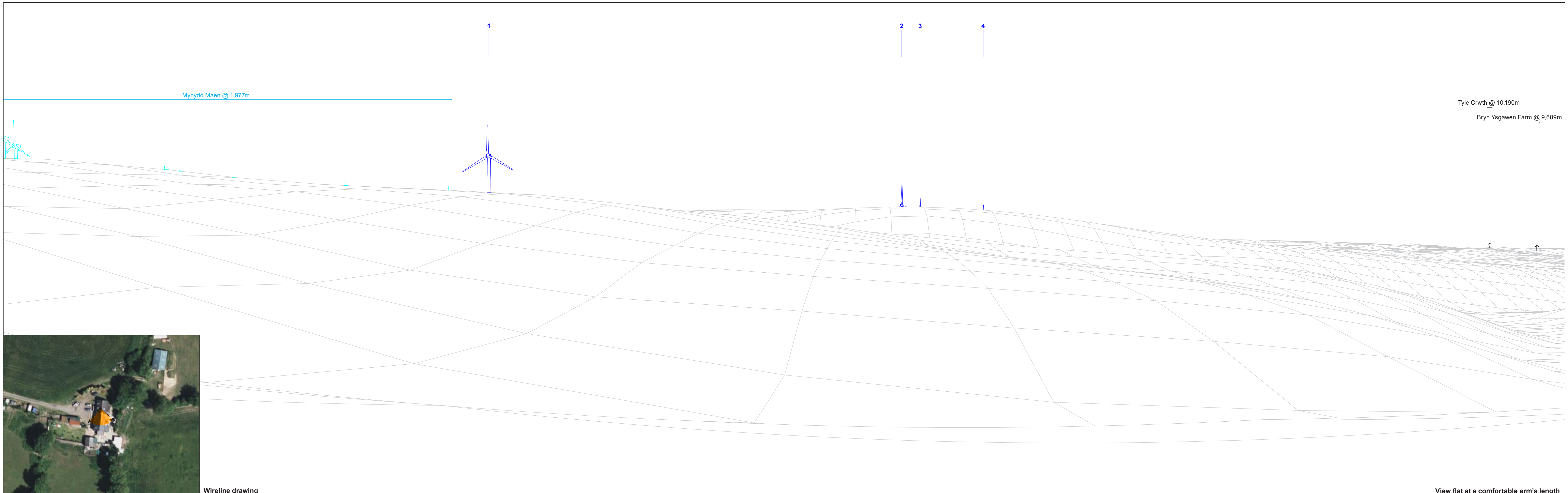

Wireline drawing

View flat at a comfortable arm's length

**Wind Farm Key:** Trecelyn Wind Farm Existing Consented Application Scoping

OS reference:	E323 335, N199 933	Horizontal field of view:	90° (cylindrical projection)
Eye level:	303.5m AOD	Principal distance:	522mm
Direction of view:	175°	Paper size:	841mm x 297mm (half A1)
Nearest turbine:	1,007m	Correct printed image size:	820 x 130mm

Client  
Trecelyn Wind Farm  
Landscape and Visual Impact Assessment

**Figure 6.18x**  
**Residential 24: Blaen-Ilwynau**

October 2023



C:\Users\UKLEL75\OneDrive - WSP\03651Temp\Windfarm\Trecelyn\Residential Wirelines\02261426-WSP-FG-OL-00005\_R1.lined

Originator: Bryce



C:\Users\UKLE775\OneDrive - WSP\03651Temp\Windfarm\Trecelyn\Design\Residential Wirelines 02261426-WSP-FG-DL-00005\_R1.indd Originator: Bryce

Mynydd Llanhilleth @ 5,035m

Mynydd Maen @ 4,165m

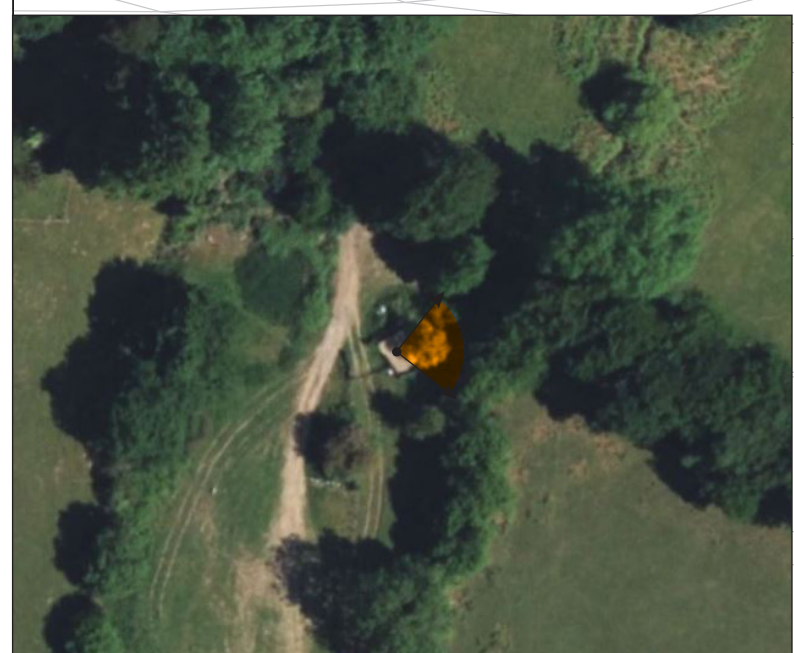

Wireline drawing

Wind Farm Key: Trecelyn Wind Farm Existing Consented Application Scoping

OS reference: E320 974, N196 460  
Eye level: 139.5m AOD  
Direction of view: 83°  
Nearest turbine: 1,956m  
Horizontal field of view: 90° (cylindrical projection)  
Principal distance: 522mm  
Paper size: 841mm x 297mm (half A1)  
Correct printed image size: 820 x 130mm

Client

Trecelyn Wind Farm  
Landscape and Visual Impact Assessment

Figure 6.18y  
Residential 25: Penrhiwbicca

View flat at a comfortable arm's length

October 2023



Mynydd Llanhilleth @ 5,469m

Mynydd Maen @ 4,250m

1

2

3

4

Originator: Brycc

C:\Users\UKLEL75\OneDrive - WSP\03651Temp\Windfarm\Trecelyn\Residential Wireline 62281426-WSP-FG-DL-00005\_R1.indd

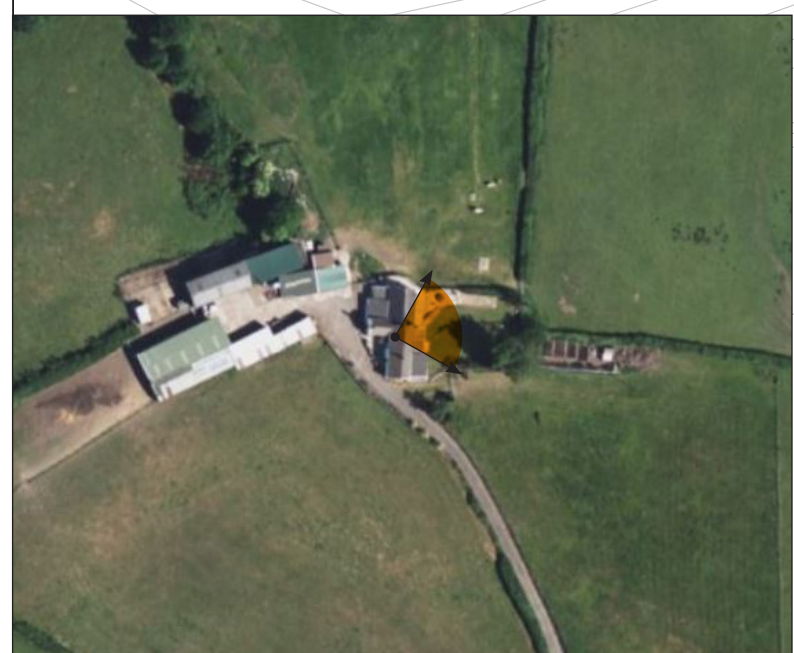

Wireline drawing

Wind Farm Key: Trecelyn Wind Farm Existing Consented Application Scoping

OS reference:	E320 859, N196 032	Horizontal field of view:	90° (cylindrical projection)
Eye level:	213.5m AOD	Principal distance:	522mm
Direction of view:	75°	Paper size:	841mm x 297mm (half A1)
Nearest turbine:	2,005m	Correct printed image size:	820 x 130mm

Client

Trecelyn Wind Farm  
Landscape and Visual Impact Assessment

Figure 6.18z  
Residential 26: Pennar-fach

View flat at a comfortable arm's length

October 2023





C:\Users\UKCLE75\OneDrive - WSP\03651Temp\Windfarm\Trecelyn\Design\Residential Wirelines 62261426-WSP-FG-OL-00005\_R1.rvt

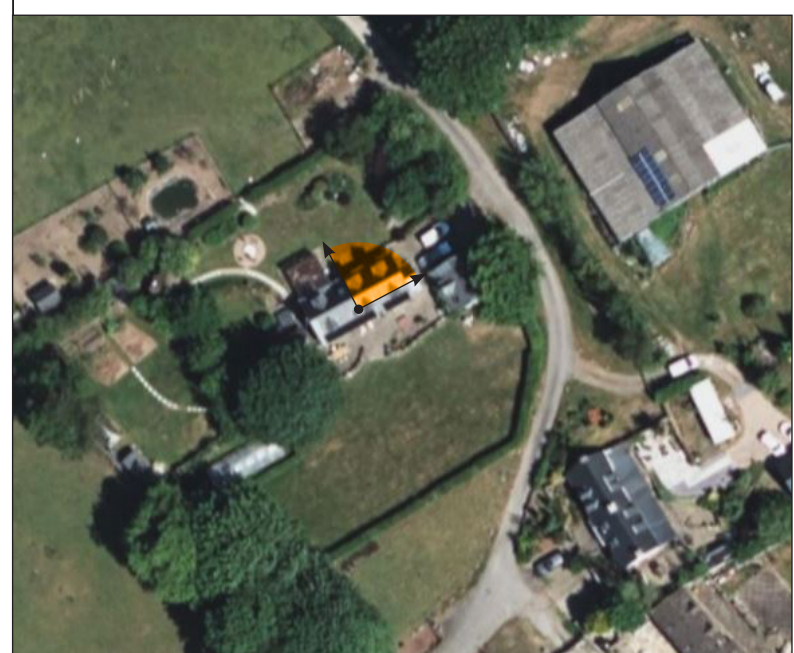
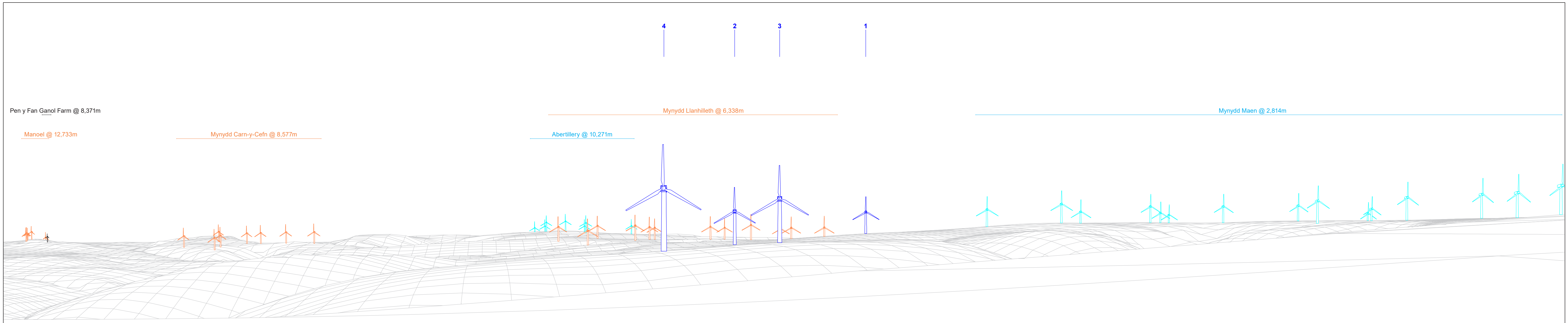

Wireline drawing

**Wind Farm Key:** ✦ Trecelyn Wind Farm ✦ Existing ✦ Consented ✦ Application ✦ Scoping

OS reference: E322 624, N194 634  
 Eye level: 340.5m AOD  
 Direction of view: 17°  
 Nearest turbine: 1,339m  
 Horizontal field of view: 90° (cylindrical projection)  
 Principal distance: 522mm  
 Paper size: 841mm x 297mm (half A1)  
 Correct printed image size: 820 x 130mm

Client: Trecelyn Wind Farm Landscape and Visual Impact Assessment

Figure 6.18aa Residential 27: Stabal To Carreg

View flat at a comfortable arm's length

October 2023



C:\Users\UKCLE75\OneDrive - WSP\03651Temp\Windfarm\Trecelyn\Design\Residential Wirelines 62281426-WSP-FG-01-00005\_R1.indd

Pen y Fan Ganol Farm @ 8,390m

Mynydd Carn-y-Cefn @ 8,641m

Abertillery @ 10,424m

Mynydd Llanhilleth @ 6,493m

Mynydd Maen @ 3,08 m

4 2 3 1

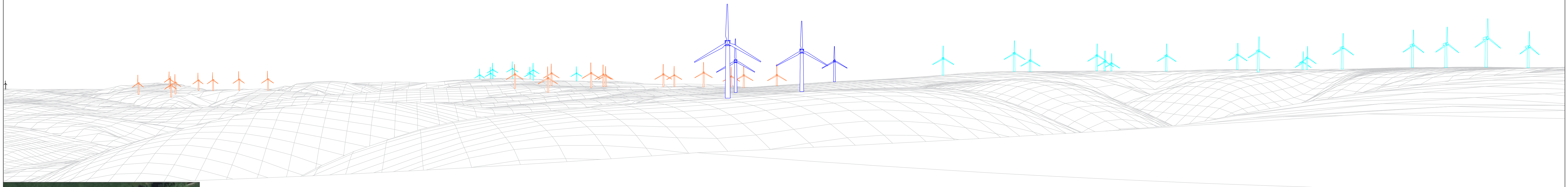

Wireline drawing

**Wind Farm Key:** ⚙ Trecelyn Wind Farm ⚙ Existing ⚙ Consented ⚙ Application ⚙ Scoping

OS reference: E322 387, N194 506  
 Eye level: 340.5m AOD  
 Direction of view: 21°  
 Nearest turbine: 1,522m

Horizontal field of view: 90° (cylindrical projection)  
 Principal distance: 522mm  
 Paper size: 841mm x 297mm (half A1)  
 Correct printed image size: 820 x 130mm

Client: Trecelyn Wind Farm Landscape and Visual Impact Assessment

Figure 6.18ab Residential 28: Cefn Rhyswg Farm

October 2023

View flat at a comfortable arm's length





C:\Users\UKLE75\OneDrive - WSP\03651Temp\Windfarm\Trecelyn\Design\Residential Wirelines 62261426-WSP-FG-OL-00005\_R1.lined

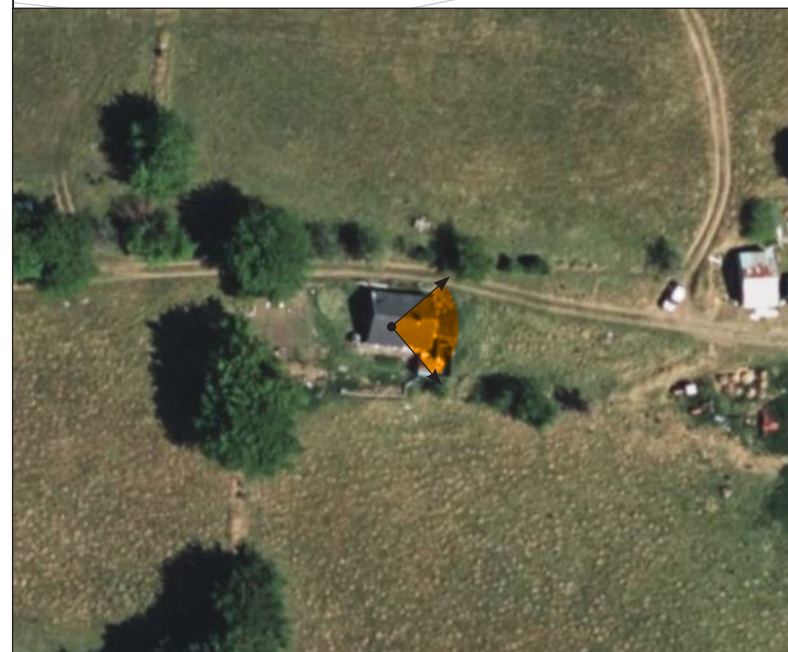

Wireline drawing

Wind Farm Key: Trecelyn Wind Farm Existing Consented Application Scoping

OS reference: E323 736, N194 803  
Eye level: 135.5m AOD  
Direction of view: 94°  
Nearest turbine: 1,760m  
Horizontal field of view: 90° (cylindrical projection)  
Principal distance: 522mm  
Paper size: 841mm x 297mm (half A1)  
Correct printed image size: 820 x 130mm

Client

Trecelyn Wind Farm  
Landscape and Visual Impact Assessment

Figure 6.18ac  
Residential 28: Rhyswg-Ganol

View flat at a comfortable arm's length  
October 2023

